



since 1970

Hakkımızda

FEN-İŞ MAKİNA, 1970 yılında Durmuş AKKUŞ tarafından marangoz zımpara makinaları imalatı ile makine imalat sektörüne adım atmış, 1974 yılından itibaren zımpara taş motorları ile imalatını geliştirmiştir. 1990 yılından itibaren ahşap, alüminyum ve PVC kesmek için kullanılan portatif dereceli gönye kesme makineleri ile birlikte kırlangıç makinesi, tas menteşe yeri açma makineleri ve sektörün ihtiyaçlarını göz önüne alarak, çeşitli ahşap işleme makinelerini imalatına dahil ederek ürün yelpazesini geliştirmeye devam etmiştir. Geniş ürün yelpazesi ile alüminyum, PVC ve ahşap işleme makineleri üreten Fen-ış Makina, üç farklı sektörün ihtiyaçlarına yönelik makineler üreten talebe göre kişiye özel çözümler de sunabilen bir marka haline gelmiştir.

Kuruluşundan bugüne **kalite** ve **güven** ilkesini benimsemiş, 54 yıllık köklü bir geçmişe sahip, iki kuşaktır bu sektörde var olan ve bu varlığını kuruluşundan bu yana kendini geliştirerek devam ettirmekte olan bir markadır.

Yurt içinde, 54 yıllık **kalite** ve **güven** ilkesinin sonucu olarak kullanıcıların vazgeçilmezi olan Fen-ış Makina, yurt dışında 40 ülkeyi aşkın ihracat hacmiyle çeşitli ülkelerde satış faaliyetlerini sürdürerek, her geçen gün sayıları artmakta olan dünya genelinde bayi ağı ile müşterileri taleplerine hızlı ve kaliteli çözümler sunmaktadır.

Kalite ve güven ilkesiyle hareket eden, kalitesini Kalite Yönetim Sistemi (**ISO 9001**) ve Avrupa Güvenlik Standartlarına Uygunluk (**CE**) belgesi ile kanıtlamış bir markadır.

FEN-İŞ MAKİNA firmasının bu başarılarının ardında piyasanın gereksinimlerini iyi tespit edebilmesi, teknolojik gelişmeleri yakından takip ederek uygulaması, insan kaynaklarına ve çalışanlarına verdiği önem, müşteri odaklı sistem ve bilgiyi tabana yayma politikası bulunmaktadır.

About Us

Fen-is Machinery, established by Durmuş AKKUŞ in 1970, stepped into the machinery manufacturing sector with the production of carpenter sanding machines and has improved its manufacturing with sanding stone motors since 1974. Since 1990, it has continued to develop its product range by including miter cutting machines used for cutting wood, aluminum and PVC, including dovetail machines, hinge opening machines and various wood processing machines in the industry's needs. Producing aluminum, PVC and wood processing machines with its wide range of products, Fen-is Machinery produces machines for the needs of these three different sectors. It has become a brand that can offer tailor-made solutions according to demand.

It is a company with a history of 54 years that has adopted the principle of **quality** and **trust** since its establishment. It is a brand that has been in this sector for two generations and has been continuing this existence by developing itself since its establishment.

Fen-is Machinery, which is indispensable for the users in the domestic market as a result of the 54-year **quality** and **trust** principle, has reached an export volume of more than 40 countries abroad. It provides fast and high-quality solutions to customer demands by continuing its sales activities in various countries and with its worldwide dealer network, which is increasing day by day.

Our company, which has been acting with the principle of quality and trust for 54 years, is a brand that has proven its quality with the Quality Management System (**ISO 9001**) and European Safety Standards Compliance (**CE**) certificate.

Behind the success of Fen-is Machinery, there is a policy of determining the needs of the market well, following the technological developments closely, the importance given to human resources and employees, customer-oriented system and dissemination of information to the base.

since 1970

TURKEY



kesim makineleri cutting machines	FN 300	4
	FN 320	5
	FN 400M	6
	FN 400S	7
	FN 400P	8
	FN 400HP	9
	FN 350AC	10
	FN 420AC	11
	FN 300CK	12
kopya freze makineleri copy router machines	FN 710FR	14
	FN 700FR	15
	FN 720FR	16
	FN 730FR	17
	FN 770FR	18
köşe pres makinesi corner crimping machine	FN 180HP	19
orta kayıt alıştırma makineleri end milling machines	FN 880KM	20
	FN 800KM	21
menteşe yeri açma makineleri hinge slot drilling machines	FN 2500	22
	FN 900PLUS	24
	FN 950PLUS	25
	FN 2450	26
	FN 1850	27
	FN 1250	28
ahşap işleme makineleri wood processing machines	FN 1000	29
	FN 1100	30
	FN 500	31
	FN 600	31
	FN 250	32
	FN 220	32
	FN 380	32
diğer ekipmanlar other equipments	FN 3000K	33
	FN 3000DK	33
	FN ST300	33

FN 300

Portatif Kesim Makinesi Ø 300mm
Portable Mitre Saw Machine Ø 300mm



ALU
PVC
WD

TR Özellikler

- FN 300 alüminyum, ahşap ve plastik profillerin düz ve dereceli kesim işlemleri için kullanılır.
- 45° ve +45° arasında istenen tüm açılarda kesim, sağa ve sola 15°, 22,5°, 30°, 45°,90° sabit açıda kesim imkanı
- Üst tablada kesim
- Testere muhafazası ve sağlam yay sistemi ile emniyetli kesim
- 1.5hp elektrik motoru sayesinde güçlü ve hassas kesim operasyonları
- Özel alaşımlı alüminyum döküm makine gövdesi
- Uzun ömürlü elektrostatik boya

Standart Ekipmanlar

- Profil dayama
- 1x yatay mengene

Opsiyonel Ekipmanlar

- Ø 300 mm testere
- FN ST300 Makine sehpası
- Motor fren sistemi
- Trifaze sistem
- İkinci mengene

EN Features

- FN300 Portable Mitre Saw Machine is used for straight and angular cutting processes of aluminum, wooden and plastic materials.
- Cutting at any desired angle between -45°, +45° and 0°, 15°, 22.5°, 30°, 45° right and left angle fixing
- Ability to cut on the upper table
- Safe cutting with saw barrier and strong spring system
- Strong and precision cutting operations with 1.5hp electric motor
- Special aluminum alloy machine body
- Durable electrostatic paint

Standard Equipments

- Profile support
- 1x horizontal clamp

Optional Equipments

- Ø 300 mm saw blade
- FN ST300 Machine Cabinet
- Motor brake unit
- Three-phase system
- Second clamp

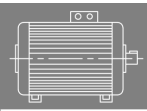
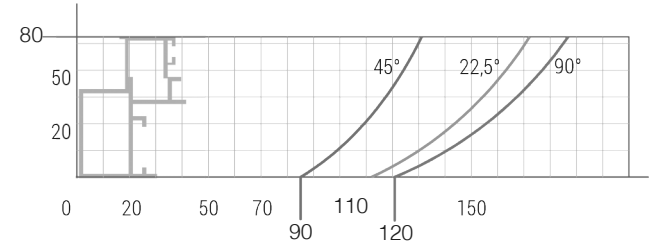
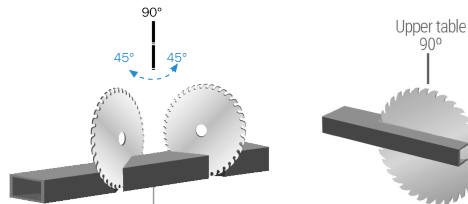

HP 1.5
kW 1.1
n 3.000 r.p.m
V 220-240
Hz 50-60
A 3

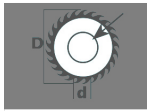

ØD 300 mm
Ød 30-32 mm
S 3.2 mm
n 3000 r.p.m

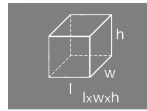

600 x 460 x 370mm



27 kg / 29 kg

FN 320

Portatif Yatarlı Kesim Makinesi Ø 300mm
Portable Mitre Saw Machine Ø 300mm
(tilting head)

ALU
PVC
WD



TR Özellikler

- FN 320 alüminyum, ahşap ve plastik profillerin düz ve dereceli kesim işlemleri için kullanılır.
- 45° ve +45° arasında istenen tüm açılarda kesim, sağa ve sola 15°, 22,5°, 30°, 45°,90° sabit açıda kesim imkanı
- 0-45° aralığında sol tarafa yatarlı kesim imkanı
- Üst tablada kesim
- Testere muhafazası ve sağlam yay sistemi ile emniyetli kesim
- 1.5hp elektrik motoru sayesinde güçlü ve hassas kesim operasyonları
- Özel alaşımli alüminyum döküm makine gövdesi
- Uzun ömürlü elektrostatik boya

Standart Ekipmanlar

- Profil dayama
- 1x yatay mengine

Opsiyonel Ekipmanlar

- Ø 300 mm testere
- FN ST300 Makine sehpası
- Motor fren sistemi
- Trifaze sistem
- İkinci mengine

EN Features

- FN320 Portable Mitre Saw Machine is used for straight and angular cutting processes of aluminum, wooden and plastic materials.
- Cutting at any desired angle between -45°, +45° and 0°, 15°, 22.5°, 30°, 45° right and left angle fixing
- Head with ability to tilt left between 0° and 45°
- Ability to cut on the upper table
- Safe cutting with saw barrier and strong spring system
- Strong and precision cutting operations with 1.5hp electric motor
- Special aluminum alloy machine body
- Durable electrostatic paint

Standard Equipments

- Profile support
- 1x horizontal clamp

Optional Equipments

- Ø 300 mm saw blade
- FN ST300 Machine Cabinet
- Motor brake unit
- Three-phase system
- Second clamp

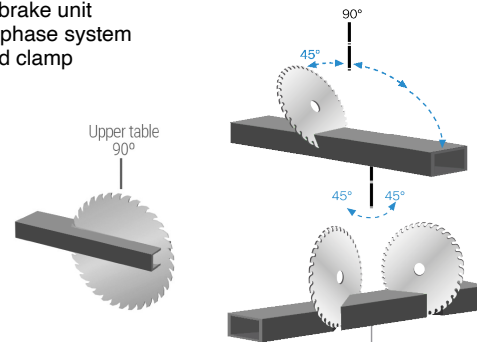
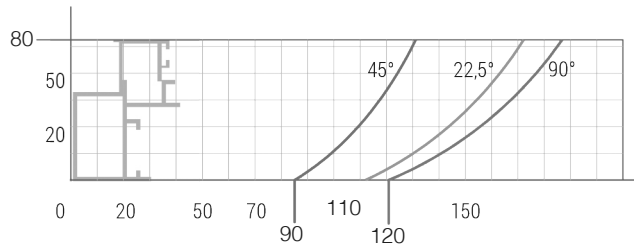

HP 1.5 kW 1.1 n 3.000 r.p.m V 220-240 Hz 50-60 A 3

ØD 300 mm Ød 30-32 mm S 3.2 mm n 3000 r.p.m

600 x 460 x 370mm

27 kg / 29 kg

FN 400M

Portatif Kesim Makinesi Ø400mm
Portable Mitre Saw Machine Ø400mm



ALU
PVC
WD



TR Özellikler

- FN 400M alüminyum, ahşap ve plastik profillerin düz ve dereceli kesim işlemleri için kullanılır.
- 45° ve +45° arasında istenen tüm açılarda kesim, sağa ve sola 15°, 22,5°, 30°, 45°,90° sabit açıda kesim imkanı
- Testere muhafazası ve sağlam yay sistemi ile emniyetli kesim
- 3 hp elektrik motoru sayesinde güçlü ve hassas kesim operasyonları
- Manuel kesim ve çalışma sistemi
- Özel alaşımli alüminyum döküm makine gövdesi
- Uzun ömürlü elektrostatik boya

Standart Ekipmanlar

- 2x yatay manuel mengene
- Ø400mm testere

Opsiyonel Ekipmanlar

- FN 3000K Konveyör
- Motor fren sistemi
- Monofaze sistem

EN Features

- FN 400M Mitre Saw Machine is used for straight and angular cutting processes of aluminum, wooden and plastic materials.

- Cutting at any desired angle between -45°, +45° and 0°, 15°, 22.5°, 30°, 45° right and left angle fixing
- Safe cutting with saw barrier and strong spring system
- Strong and precision cutting operations with 3 hp electric motor
- Manual cutting and operating system
- Special aluminum alloy machine body
- Made of steel sheet machine stand
- Durable electrostatic paint
- Vibration isolating lower base rubbers

Standard Equipments

- 2x manual horizontal clamps
- Ø400mm saw blade

Optional Equipments

- FN 3000K Conveyor
- Motor brake unit
- Single-phase system

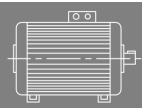
HP 3 kW 2.2 n 3.000 r.p.m V 380-400 Hz 50-60 A 8

ØD 400 mm Ød 30-32 mm n 3000 r.p.m

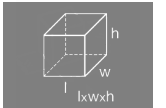
830x830x710 mm

75 kg / 100 kg

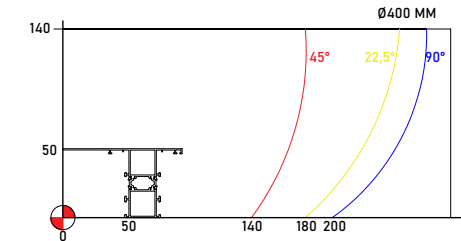
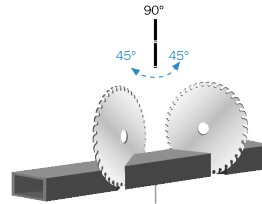

FN 400S

Manuel Kesim Makinesi Ø 400mm
Manual Mitre Saw Machine Ø400mm

ALU
PVC
WD

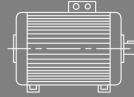

HP 3 kW 2.2 n 3.000 r.p.m V 380-400 Hz 50-60 A 8

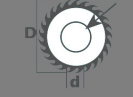
Ød 400 mm Ød 30-32 mm n 3000 r.p.m

830x830x1490mm

125 kg / 169 kg

TR Özellikler

- FN 400S alüminyum, ahşap ve plastik profillerin düz ve dereceli kesim işlemleri için kullanılır.
- 45° ve +45° arasında istenen tüm açılarda kesim, sağa ve sola 15°, 22,5°, 30°, 45°,90° sabit açıda kesim imkanı
- Testere muhafazası ve sağlam yay sistemi ile emniyetli kesim
- 3 hp elektrik motoru sayesinde güçlü ve hassas kesim operasyonları
- Manuel kesim ve çalışma sistemi
- Manuel mengenerler
- Özel alaşımli alüminyum döküm makine gövdesi
- Çelik sacdan üretilmiş kullanışlı makine sehпасı
- Uzun ömürlü elektrostatik boya

Standart Ekipmanlar

- Ø400 mm testere
- 2x manuel yatay menegene

Opsiyonel Ekipmanlar

- FN 3000K Konveyör
- Monofaze sistem
- Motor Fren Sistemi
- Soğutma sistemi

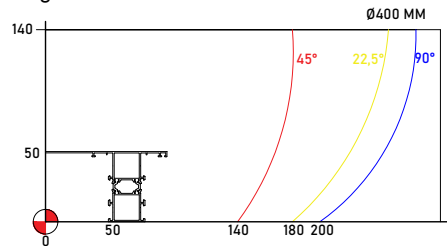

EN Features

- FN 400S Mitre Saw Machine is used for straight and angular cutting processes of aluminum, wooden and plastic materials.
- Cutting at any desired angle between -45°, +45° and 0°, 15°, 22.5°, 30°, 45° right and left angle fixing
- Safe cutting with saw barrier and strong spring system
- Strong and precision cutting operations with 3 hp electric motor
- Manual cutting and operating system
- Manual clamps
- Special aluminum alloy machine body
- Made of steel sheet machine stand
- Durable electrostatic paint

Standard Equipments

- Ø400mm saw blade
- 2x manual horizontal clamps

Optional Equipments

- FN 3000K Conveyor
- Single-phase system
- Motor brake unit
- Cooling system

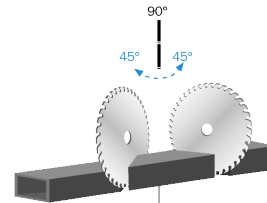

FN 400P

Dereceli Kesim Makinesi Ø400mm (pnömatik)
Mitre Saw Machine Ø400mm (pneumatic)



ALU
PVC
WD

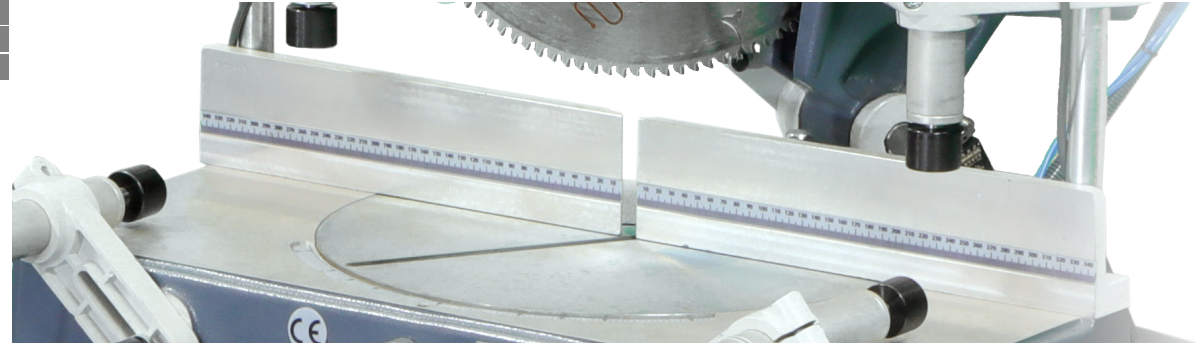

TR Özellikler

- FN 400P alüminyum, ahşap ve plastik profillerin düz ve dereceli kesim işlemleri için kullanılır.
- 45° ve +45° arasında istenen tüm açılarda kesim, sağa ve sola 15°, 22,5°, 30°, 45°,90° sabit açıda kesim imkanı
- Testere muhafazası ve sağlam yay sistemi ile emniyetli kesim
- 3 hp elektrik motoru sayesinde güçlü ve hassas kesim operasyonları
- Manuel kesim ve pnömatik çalışma sistemi
- Pnömatik yatay ve dikey mengenerler
- Hidro-pnömatik kesim işlemi (opsiyonel)
- Özel alaşımlı alüminyum döküm makine gövdesi
- Çelik sacdan üretilmiş kullanışlı makine sehпасı
- Uzun ömürlü elektrostatik boya

Standart Ekipmanlar

- Ø400 mm testere
- Soğutma sistemi
- 2x pnömatik yatay menegene
- 2x pnömatik dikey menegene
- Hava tabancası

Opsiyonel Ekipmanlar

- FN 3000K / FN 3000DK Konveyör
- Monofaze sistem
- Motor Fren Sistemi

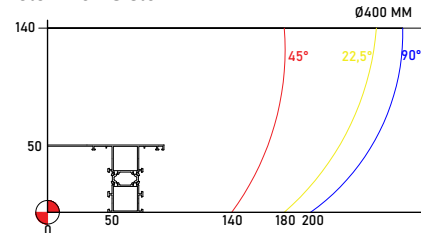

EN Features

- FN 400P Mitre Saw Machine is used for straight and angular cutting processes of aluminum, wooden and plastic materials.
- Cutting at any desired angle between -45°, +45° and 0°, 15°, 22.5°, 30°, 45° right and left angle fixing
- Safe cutting with saw barrier and strong spring system
- Strong and precision cutting operations with 3 hp electric motor
- Manual cutting and pneumatic operating system
- Pneumatic vertical and horizontal clamps
- Hydro-pneumatic cutting operation (optional)
- Special aluminum alloy machine body
- Made of steel sheet machine stand
- Durable electrostatic paint

Standard Equipments

- Ø400mm saw blade
- Cooling system
- 2x pneumatic horizontal clamps
- 2x pneumatic vertical clamps
- Air gun

Optional Equipments

- FN 3000K / FN 3000DK Conveyor
- Single-phase system
- Motor brake unit

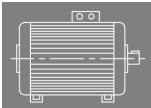
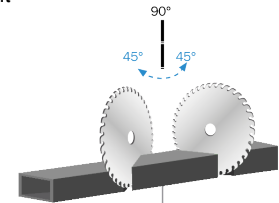

HP 3
kW 2.2
n 3.000 r.p.m
V 380-400
Hz 50-60
A 8



ØD 400 mm
Ød 30-32 mm
n 3000 r.p.m



6 - 8 BAR

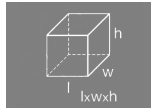

830x830x1490mm



135 kg
/ 184 kg

FN 400HP

Otomatik Kesim Makinesi Ø400mm
(hidro-pnömatik)
Automatic Mitre Saw Machine Ø400mm
(hydro-pneumatic)

ALU
PVC
WD

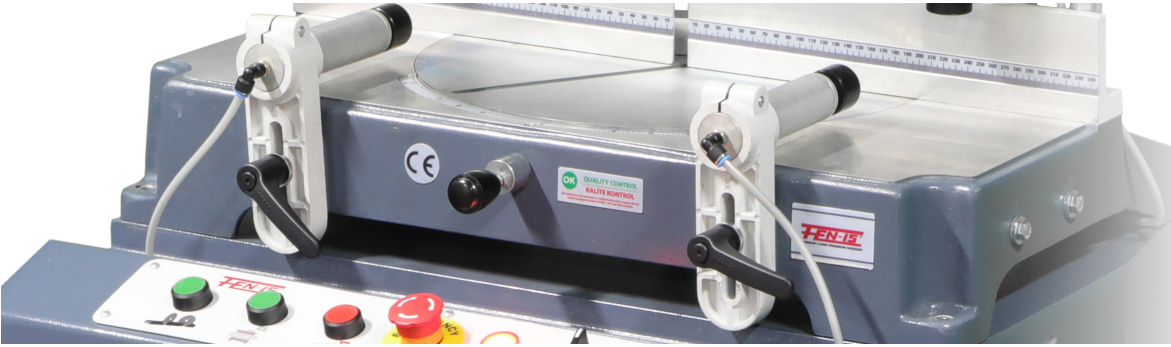

TR Özellikler

- FN 400HP alüminyum, ahşap ve plastik profillerin düz ve dereceli kesim işlemleri için kullanılır.
- 45° ve +45° arasında istenen tüm açılarda kesim, sağa ve sola 15°, 22,5°, 30°, 45°,90° sabit açıda kesim imkanı
- Testere muhafazası ve sağlam yay sistemi ile emniyetli kesim
- 3 hp elektrik motoru sayesinde güçlü ve hassas kesim operasyonları
- Otomatik kesim ve hidro-pnömatik çalışma sistemi
- Pnömatik yatay ve dikey mengenerler
- Darbelere dayanıklı döküm tabla
- Özel alaşımli alüminyum döküm makine gövdesi
- Çelik sacdan üretilmiş kullanışlı makine sehpası
- Uzun ömürlü elektrostatik boya

Standart Ekipmanlar

- Ø400mm testere
- Soğutma sistemi
- 2x pnömatik yatay menegene
- 2x pnömatik dikey menegene
- Hava tabancası

Opsiyonel Ekipmanlar

- FN 3000K / FN 3000DK Konveyör
- Monofaze sistem
- Motor Fren Sistemi

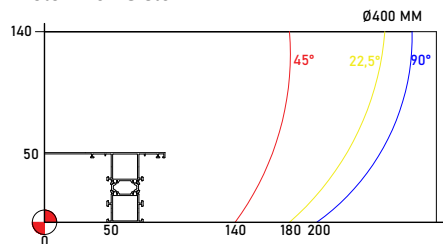

EN Features

- FN 400HP Automatic Mitre Saw Machine is used for straight and angular cutting processes of aluminum, wooden and plastic materials.
- Cutting at any desired angle between -45°, +45° and 0°, 15°, 22.5°, 30°, 45° right and left angle fixing
- Safe cutting with saw barrier and strong spring system
- Strong and precision cutting operations with 3 hp electric motor
- Automatic cutting and hydro-pneumatic operating system
- Pneumatic vertical and horizontal clamps
- Cast core with impact resistance
- Machine body made of special aluminum alloy
- Made of steel sheet machine stand
- Durable electrostatic paint

Standard Equipments

- Ø400mm saw blade
- Cooling system
- 2x pneumatic horizontal clamps
- 2x pneumatic vertical clamps
- Air gun

Optional Equipments

- FN 3000K / FN 3000DK Conveyor
- Single-phase system
- Motor brake unit

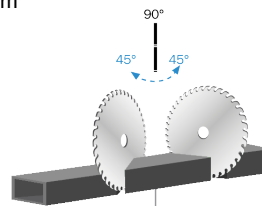

HP 3 kW 2.2 n 3.000 r.p.m V 380-400 Hz 50-60 A 8

ØD 400 mm Ød 30-32 mm n 3000 r.p.m

6 - 8 BAR

830x830x1490mm

135 kg / 184 kg

FN 350AC

Otomatik Alttan Çıkma Kesim Makinesi Ø350mm
Automatic Up-Cutting Saw Machine Ø350mm



ALU
PVC
WD

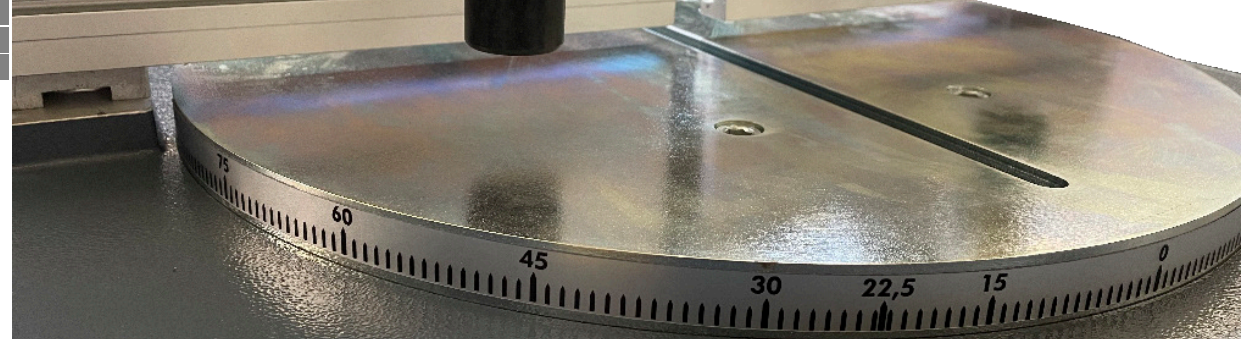

TR Özellikler

– FN 350AC alüminyum, ahşap ve plastik profillerin düz ve dereceli kesim operasyonları için, kullanıcıya sunulan otomatik kesim makinesidir. Biçme ve enine kesme operasyonları amaçlı olarak kullanılabilir.

- Hidro-Pnömatik sistem ile yukarı hareket eden testere mekanizması
- Profile göre kesme hızını ayarlama
- Muhafaza ile güvenli kesim işlemi
- -90° ve +45° arasında istenen tüm açılarda kesim, sağa ve sola 15°, 22,5°, 30°, 45°, 60°, 67,5°, 75° ve 90° sabit açıda kesim imkanı
- 180° dönebilen tabla enine ve boyuna kesme (biçme) yapabilme imkanı
- Kesme kapasitesini arttıran hareketli gönye
- Pnömatik dikey ve yatay mengenerler
- Kolay testere değiştirme

Standart Ekipmanlar

- Ø350 mm testere
- 2x pnömatik dikey mengene
- Soğutma sistemi
- Gönye dayama

Opsiyonel Ekipmanlar

- FN 3000K / FN 3000DK Konveyör
- Monofaze sistem

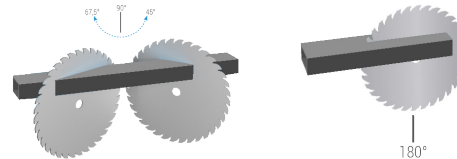

EN Features

– FN 350AC Automatic Up-Cutting Saw Machine is used for straight and angular cutting operations of aluminum, wooden and plastic materials. The machine can be used the lateral cutting mode and longitudinal cutting mode.

- Hydro-Pneumatic cutting process
- Cutting speed adjustment based on the profile
- Safety cutting with safeguard system
- Cutting at any desired angle between -90°, +45° and 15°, 22.5°, 30°, 45°, 60°, 67.5°, 75° ve 90° right and left angle fixing.
- It has the ability of lateral and longitudinal cutting operations with 180° rotary plate
- Increase in cutting capacity with mobile miter
- Pneumatic vertical and horizontal clamps
- Changing the saw blade ease

Standard Equipments

- Ø350mm saw blade
- 2x pneumatic vertical clamps
- Cooling system
- Back fence

Optional Equipments

- FN 3000K / FN 3000DK Conveyor
- Single-phase system

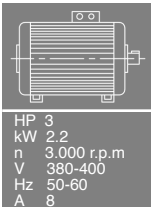
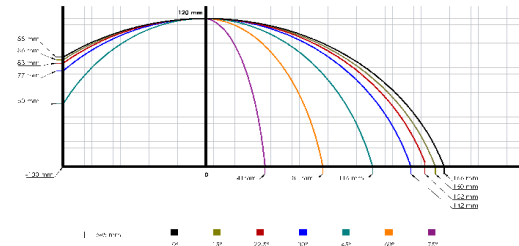

HP 3
kW 2.2
n 3.000 r.p.m
V 380-400
Hz 50-60
A 8

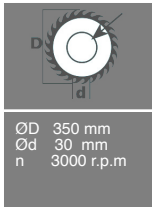

ØD 350 mm
Ød 30 mm
n 3000 r.p.m

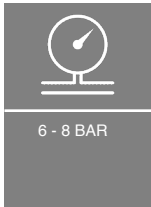

6 - 8 BAR

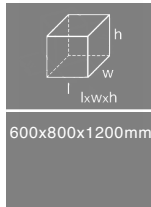

600x800x1200mm



165 kg /
205 kg

FN 420AC

Otomatik Alttan Çıkma Kesim Makinesi Ø420mm
Automatic Up-Cutting Saw Machine Ø420mm

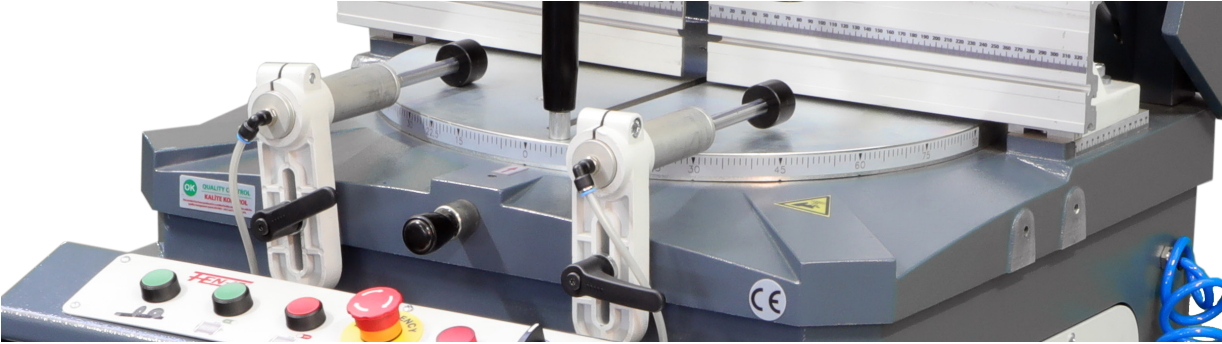

ALU
PVC
WD

TR Özellikler

- FN 420AC alüminyum, ahşap ve plastik profillerin düz ve dereceli kesim operasyonları için, kullanıcıya sunulan otomatik kesim makinesidir. Biçme ve enine kesme operasyonları amaçlı olarak kullanılabilir.
- Hidro-Pnömatik sistem ile yukarı hareket eden testere mekanizması
- Profile göre kesme hızını ayarlama
- Muhafaza ile güvenli kesim işlemi
- -90° ve +45° arasında istenen tüm açılarda kesim, sağa ve sola 15°, 22,5°, 30°, 45°, 60°, 67,5°, 75° ve 90° sabit açıda kesim imkanı
- 180° dönebilen tabla enine ve boyuna kesme (biçme) yapabilme imkanı
- Kesme kapasitesini arttıran hareketli gönye
- Pnömatik dikey ve yatay mengenerler
- Kolay testere değiştirme

Standart Ekipmanlar

- Ø420 mm testere
- 2 x pnömatik dikey mengene
- 2 x pnömatik yatay mengene
- Soğutma sistemi
- Gönye dayama
- FN 3000K Sağ Konveyör

Opsiyonel Ekipmanlar

- FN 3000K / FN 3000DK Konveyör
- Monofaze sistem

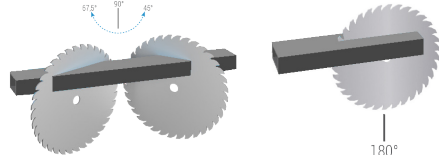

EN Features

- FN 420AC Automatic Up-Cutting Saw Machine is used for straight and angular cutting operations of aluminum, wooden and plastic materials. The machine can be used the lateral cutting mode and longitudinal cutting mode.
- Hydro-Pneumatic cutting process
- Cutting speed adjustment based on the profile
- Safety cutting with safeguard system
- Cutting at any desired angle between -90°, +45° and 15°, 22.5°, 30°, 45°, 60°, 67.5°, 75° ve 90° right and left angle fixing.
- It has the ability of lateral and longitudinal cutting operations with 180° rotary plate
- Increase in cutting capacity with mobile miter
- Pneumatic vertical and horizontal clamps
- Changing the saw blade ease

Standard Equipments

- Ø420mm saw blade
- 2 x pneumatic vertical clamps
- 2 x pneumatic vertical clamps
- Cooling system
- Back fence
- FN 3000K Conveyor (right)

Optional Equipments

- FN 3000K / FN 3000DK Conveyor
- Single-phase system

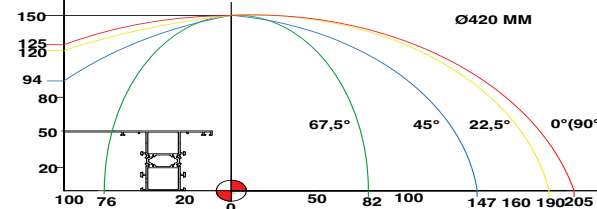

HP 3 kW 2.2 n 3.000 r.p.m V 380-400 Hz 50-60 A 8

ØD 420 mm Ød 32 mm n 3.000 r.p.m

6 - 8 BAR

700x870x1250mm

250 kg / 290 kg

FN 300CK

Otomatik Çift Kafa Kesme ve Delme Makinesi
Ø300mm (servo kontrol)

Automatic Double Head Cutting and Drilling Machine
Ø300mm (servo control)



ALU
PVC
WD



TR Özellikler

– FN 300CK, alüminyum çerçeve profillerinin 45 derece kesim ve bağlantı deliklerini delme operasyonları için kullanıcıya sunulan PLC ekran üzerinden servo kontrollü otomatik kesim makinesidir.

- 10 saniye hızlı işlem süresi
- Karşıdan gelme kesim mekanizması sayesinde çapak sız kesim operasyonu
- Kapalı testere mekanizması sayesinde güvenli kesim ve delme operasyonları
- Yüksek devirli hız frekans motoru ile kaliteli delik delme işlemi
- Festo marka servo kontrol sistemi ile 0.08mm pozisyonlama hassasiyeti
- USB veya Wifi üzerinden ekrana kesim listesi veri aktarımı
- Kullanışlı arayüz
- Uzaktan bağlanma ve teknik destek sağlama
- Hareketli grup, yağlama ünitesine sahip lineer kızaklar ile kolayca hareket edebilme
- Hidro-pnömatik sistem ile çapaksız kesim ve delme operasyon imkanı
- Ayarlanabilir testere hızı
- 120mm'ye kadar kesim imkanı
- Çift el çalışma güvenliği
- Su soğutma sistemi sayesinde kaliteli operasyonlar
- Güçlü makine şasesi
- Ergonomik ve kullanıcı dostu tasarım

Standart Ekipmanlar

- 2 x Ø300mm testere
- 2 x Kesici Bıçak

Opsiyonel Ekipmanlar

- 3.000mm kesim

EN Features

– FN 300CK is a servo-controlled automatic cutting machine via PLC screen offered to the user for 45 degree cutting and connection hole drilling operations of aluminium frame profiles.

- 10 seconds fast processing time
- Precision cutting operation thanks to the radial cutting mechanism
- Safe cutting and drilling operations thanks to the closed saw head mechanism
- Quality hole drilling operation with high-speed frequency motor
- 0.08 mm positioning accuracy with Festo brand servo control system
- Cutting list data transfer to the screen via USB or Wifi
- User-friendly software
- Providing remote connection and technical support
- Movable group, easy movement with linear guides with lubrication unit
- Precision cutting and drilling operation opportunity with hydro-pneumatic system
- Adjustable saw speed
- Cutting opportunity up to 120 mm
- Two-handed operation safety
- Quality operations thanks to water cooling system
- Strong machine chassis
- Ergonomic and user-friendly design

Standard Equipment

- 2 x Ø300mm saw blade
- 2 x Drill Bit

Optional Equipment

- 3.000mm cutting option

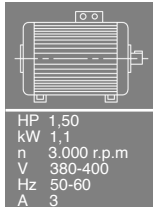

HP 1,50
kW 1,1
n 3.000 r.p.m
V 380-400
Hz 50-60
A 3

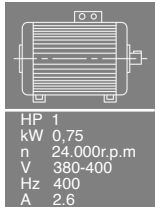

HP 1
kW 0,75
n 24.000r.p.m
V 380-400
Hz 400
A 2,6

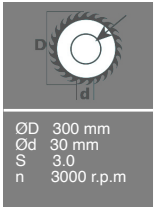

ØD 300 mm
Ød 30 mm
S 3,0
n 3000 r.p.m

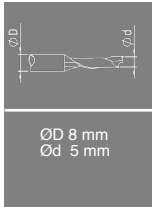

ØD 8 mm
Ød 5 mm

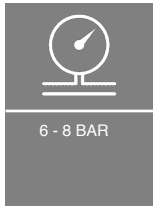

6 - 8 BAR

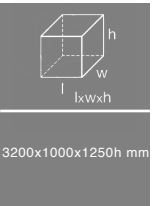

3200x1000x1250h mm



500 kg / 560 kg

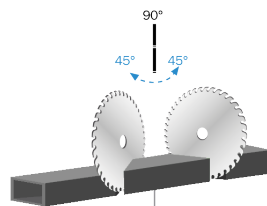

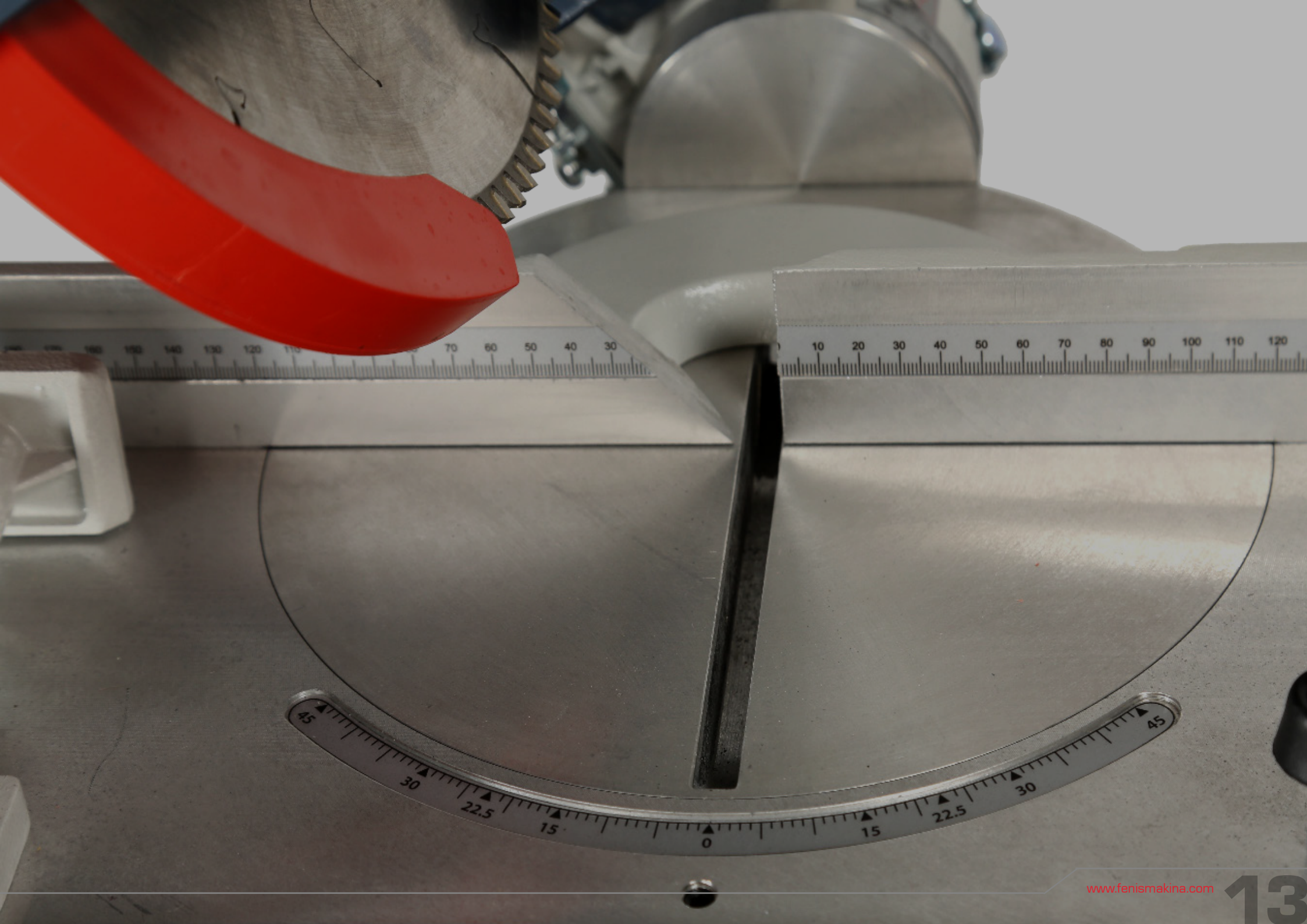

FN 710FR

Portatif Kopya Freze Makinesi Portable Copy Router Machine



ALU
PVC
WD



TR Özellikler

- FN 710FR, alüminyum ve plastik profillere ispanyolet yuvaları, su tahliye kanalları, kilit, kol yeri, menteşe, kanal açma gibi bir çok frezeleme ve delik delme işlemleri için kullanılır.
- Çeşitli delik açma işlemleri için kaliteli operasyon olanağı
- İşleme uygun kopya tertibatı
- Ergonomik tasarımı ve elektrik motoru sayesinde güvenli ve kaliteli frezeleme operasyonları
- Özel alaşımlı alüminyum döküm makine gövdesi
- Kaplamalı saç metal şablon
- Krom kaplı paslanmaz miller
- Dayamalar yardımıyla kopya tertibatından bağımsız olarak çeşitli kanallar açma

Standart Ekipmanlar

- 5mm freze ucu (1 adet)
- 2x sağ-sol profil dayama
- 2x manuel yatay mengene
- Kopya şablonu

Opsiyonel Ekipmanlar

- Su soğutma sistemi
- İlave freze ucu
- Özel kopya tertibatı
- FN ST300 Makine sehpası

EN Features

- FN 710FR, used for cutting appropriate slots on aluminum and plastic profiles for locks, espagnolette holes, drilling handles, hinges and opening water drain slot.
- Quality operation for various drilling operations
- Copy assembly matching the process
- Quality and secure operations by ergonomic design and electrical motor
- Machine body made of special aluminum alloy
- Chrome electroplated copy template
- Corrosion proof bearing shaft
- Ability to open various channels independently of the copy assembly with profile gauges

Standard Equipments

- 5mm milling cutter (1 pcs)
- 2x right and left profile gauge
- 2x manual horizontal clamp
- Copy remplate

Optional Equipments

- Water cooling system
- Additional milling cutter
- Special copy assembly
- FN ST300 Machine cabinet

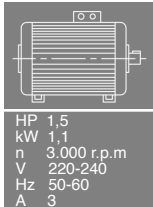

HP 1,5
kW 1,1
n 3.000 r.p.m
V 220-240
Hz 50-60
A 3

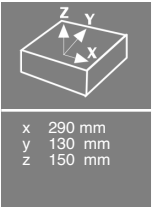

x 290 mm
y 130 mm
z 150 mm

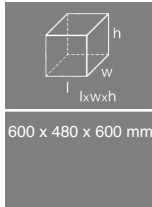

600 x 480 x 600 mm

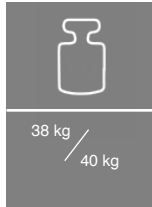

38 kg / 40 kg

FN 700FR

Portatif Kopya Freze Makinesi
Portable Copy Router Machine

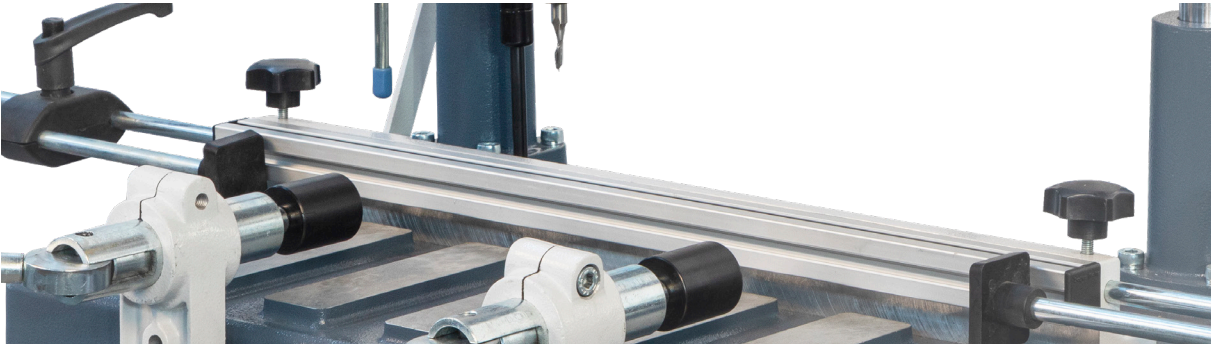

ALU
PVC
WD



TR Özellikler

- FN 700FR, alüminyum ve plastik profillere ispanyolet yuvaları, su tahliye kanalları, kilit, kol yeri, menteşe, kanal açma gibi bir çok frezeleme ve delik delme işlemleri için kullanılır.
- Çeşitli delik açma işlemleri için kaliteli operasyon olanağı
- İşleme uygun kopya tertibatı
- Ergonomik tasarımı sayesinde güvenli ve kaliteli frezeleme operasyonları
- Özel alaşımli alüminyum döküm makine gövdesi
- Kaplamalı saç metal şablon
- Krom kaplı paslanmaz miller
- Dayamalar yardımıyla kopya tertibatından bağımsız olarak çeşitli kanallar açma

Standart Ekipmanlar

- 5mm freze ucu (1 adet)
- 2x sağ-sol profil dayama
- 2x manuel yatay mengene
- Kopya şablonu

Opsiyonel Ekipmanlar

- İlave freze ucu
- Özel kopya tertibatı
- FN ST300 Makine sehpası

EN Features

- FN 700FR, used for cutting appropriate slots on aluminum and plastic profiles for locks, espagnolette holes, drilling handles, hinges and opening water drain slot.
- Quality operation for various drilling operations
- Copy assembly matching the process
- Quality and secure operations by ergonomic design
- Machine body made of special aluminum alloy
- Chrome electroplated copy template
- Corrosion proof bearing shaft
- Ability to open various channels independently of the copy assembly with profile gauges

Standard Equipments

- 5mm milling cutter (1 pcs)
- 2x right and left profile gauge
- 2x manual horizontal clamp
- Copy remplate

Optional Equipments

- Additional milling cutter
- Special copy assembly
- FN ST300 Machine cabinet

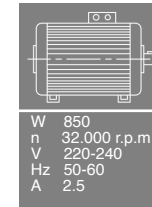

W 850
n 32.000 r.p.m
V 220-240
Hz 50-60
A 2.5

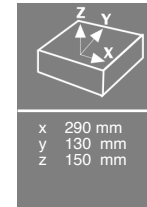

x 290 mm
y 130 mm
z 150 mm

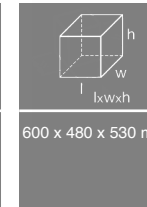

600 x 480 x 530 mm



27 kg / 29 kg

FN 720FR

Kopya Freze Makinesi (pnömatik)
Copy Router Machine (pneumatic)



ALU
PVC
WD

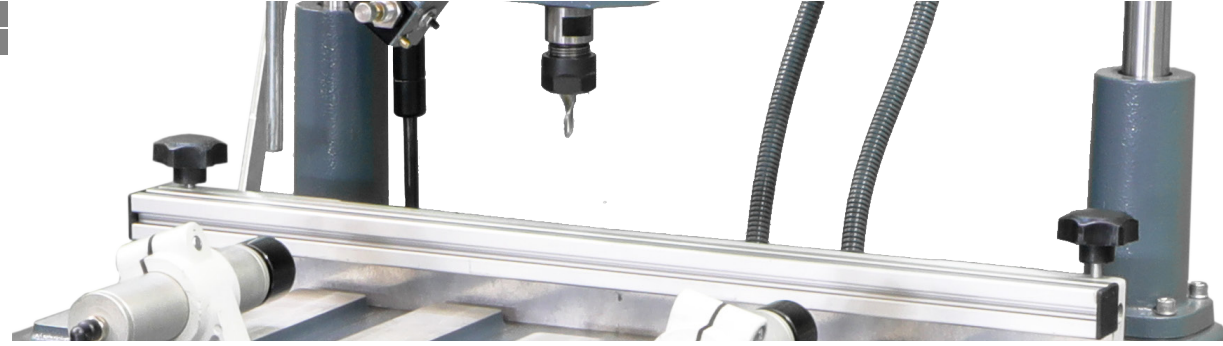

TR Özellikler

– FN 720FR, alüminyum ve plastik profillere ispanyolet yuvaları, su tahliye kanalları, kilit, kol yeri, menteşe, kanal açma gibi bir çok frezeleme ve delik delme işlemleri için kullanılır.

- Çeşitli delik açma işlemleri için kaliteli operasyon olanağı
- Motor hızı ayarlanabilir spindle kopya freze motoru
- Pnömatik yatay mengenerler (2 adet)
- Soğutma sistemi
- İşleme uygun kopya tertibatı
- Ergonomik tasarımı sayesinde güvenli ve kaliteli frezeleme operasyonları
- Özel alaşımlı alüminyum döküm makine gövdesi
- Ergonomik el kumanda ünitesi
- Kopya freze motoru direk olarak kumanda kolu üzerinden kontrol edilmektedir
- Kaplamalı saç metal şablon
- Krom kaplı paslanmaz miller
- Dayamalar yardımıyla kopya tertibatından bağımsız olarak çeşitli kanallar açma

Standart Ekipmanlar

- 5mm freze ucu
- Profil dayama
- Soğutma sistemi
- Kopya şablonu
- 2x pnömatik yatay mengene
- Hava tabancası

Opsiyonel Ekipmanlar

- İlave freze ucu
- Özel kopya tertibatı

EN Features

– FN 720FR, used for cutting appropriate slots on aluminum and plastic profiles for locks, espag nolette holes, drilling handles, hinges and opening water drain slot.

- Quality operation for various drilling operations
- Adjustable motor speed thanks to spindle copy router motor
- Pneumatic horizontal clamps (2 pcs)
- Cooling system
- Copy assembly matching the process
- Quality and secure operations by ergonomic design
- Machine body made of special aluminum alloy
- Ergonomic hand control unit
- Copy router motor is directly controlled via joystick
- Chrome electroplated copy template
- Corrosion proof bearing shaft
- Ability to open various channels independently of the copy assembly with profile gauges

Standard Equipments

- 5mm milling cutter (1 pcs)
- Profile gauge
- Cooling system
- Copy template equipped with machine
- 2x pneumatic horizontal clamp
- Air gun

Optional Equipments

- Additional milling cutter
- Special copy assembly

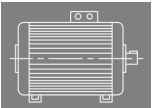

HP 1
kW 0,75
n 24.000r.p.m
V 220-240
Hz 400
A 2,6

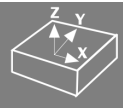

x 290 mm
y 130 mm
z 150 mm



6 - 8 BAR

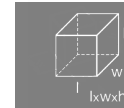

670x700x1340mm



82 kg / 122 kg

FN 730FR

Üçlü Kol Yeri Deltmeli Kopya Freze Makinesi
(hidro-pnömatik)
Copy Router Machine with Triple Handle Slot Drilling
(hydro-pneumatic)



ALU
PVC
WD



TR Özellikler

– FN 730FR, alüminyum ve plastik profillere ispanyolet yuvaları, üçlü kol yeri, su tahliye kanalları, kilit, kol yeri, menteşe, kanal açma gibi bir çok frezeleme ve delik delme işlemleri için kullanılır.

- Çeşitli delik açma işlemleri için kaliteli operasyon olanağı
- Motor hızı ayarlanabilir spindle kopya freze motoru
- Pnömatik yatay mengenerler (2 adet)
- Hidro-pnömatik sistem ile çalışan üçlü kol yeri delme sistemi
- Soğutma sistemi
- İşleme uygun kopya tertibatı
- Ergonomik tasarımı sayesinde güvenli ve kaliteli frezeleme operasyonları
- Özel alaşım alüminyum döküm makine gövdesi
- Ergonomik el kumanda ünitesi
- Kopya freze motoru direk olarak kumanda kolu üzerinden kontrol edilmektedir
- Kaplamalı saç metal şablon
- Krom kaplı paslanmaz miller
- Dayamalar yardımıyla kopya tertibatından bağımsız olarak çeşitli kanallar açma

Standart Ekipmanlar

- 5mm freze ucu
- Üçlü matkap seti
- Profil dayama
- Soğutma sistemi
- Kopya şablonu
- 2x pnömatik yatay mengene
- Hava tabancası

Opsiyonel Ekipmanlar

- İlave freze ucu
- Özel kopya tertibatı

EN Features

– FN 730FR, used for cutting appropriate slots on aluminum and plastic profiles for locks, triple holes, espagnolette holes, drilling handles, hinges and opening water drain slot.

- Quality operation for various drilling operations
- Adjustable motor speed thanks to spindle copy router motor
- Pneumatic horizontal clamps (2 pcs)
- Hydro-pneumatic triple hole drilling system
- Cooling system
- Copy assembly matching the process
- Quality and secure operations by ergonomic design
- Machine body made of special aluminum alloy
- Ergonomic hand control unit
- Copy router motor is directly controlled via joystick
- Chrome electroplated copy template
- Corrosion proof bearing shaft
- Ability to open various channels independently of the copy assembly with profile gauges

Standard Equipments

- 5mm milling cutter (1 pcs)
- Triple drill bit set
- Profile gauge
- Cooling system
- Copy template equipped with machine
- 2x pneumatic horizontal clamp
- Air gun

Optional Equipments

- Additional milling cutter
- Special copy assembly

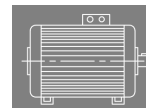

HP 1
kW 0,75
n 24.000r.p.m
V 380-400
Hz 400
A 2,6

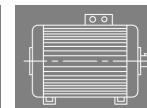

HP 1,5
kW 1,1
n 1.400 r.p.m
V 380-400
Hz 50-60
A 3

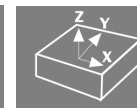

x 290 mm
y 130 mm
z 150 mm



6 - 8 BAR

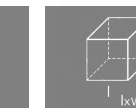

670x850x1340mm



102 kg / 135 kg

FN 770FR

Otomatik Kopya Freze Makinesi (3 eksen)
Automatic Copy Router Machine (3 axis)



ALU
PVC
WD

TR Özellikler

– FN 770FR, alüminyum ve plastik profillere 3 yüzeyinde kilit, kol yeri, menteşe, ispanyolet yuvaları ve kanal açma gibi bir çok frezeleme ve delik delme işlemleri için kullanılır.

- Motor hızı ayarlanabilir spindle kopya freze motoru
- Pnömatik mngenelerle sabitlenen malzemenin -90° ve +90° arasında hareket kabiliyeti ile 3 yüzeyinde hassas operasyon imkanı
- -90° ve +90° arasında işlem yapabilmeyi sağlamak amacı ile tablayı sabitleyen güçlü fren mekanizması
- Kolay bıçak değiştirme sistemi
- Operasyonları kolaylaştıran yüksek hassasiyetli gaz amortisörler, yataklama sistemi ve ergonomik kol tasarımı
- Soğutma sistemi
- İşleme uygun kopya tertibatı
- Dayamalar yardımıyla kopya tertibatından bağımsız kanallar açma imkanı
- Sağ ve sol tarafta konveyör, sağ konveyörde cetvel ve dayama sistemi

Standart Ekipmanlar

- 5mm freze ucu (1 adet)
- Sağ ve sol profil dayama
- Soğutma sistemi
- Kopya şablonu
- 4x pnömatik yatay mengene
- Hava tabancası

Opsiyonel Ekipmanlar

- İlave freze ucu
- Özel kopya tertibatı

EN Features

– FN 770FR, used for locks, handles, hinges, espagnolette holes, latch slots, and water drain slot opening processes with rotating the profile on 3 surfaces of aluminum and plastic profiles.

- Adjustable motor speed thanks to spindle copy router motor
- The materials hold by pneumatic clamps mounted on a tilting support can be automatically tilted on any positions, between -90° and +90°
- Equipped with strong table brake system to stop the turning table and machining the profile in any angle between -90° and +90°
- Ease tool changing system
- Smooth movement, high precision and great sensitivity provided with gas spring and ergonomic handles
- Cooling system
- Copy assembly matching the process
- Ability to open various channels independently of the copy assembly with profile gauges
- Roller support table at the right (with ruller) and left side

Standard Equipments

- 5mm milling cutter (1 pcs)
- Right and left profile gauge
- Cooling system
- Copy template equipped with machine
- 4x pneumatic horizontal clamps
- Air gun

Optional Equipments

- Additional milling cutter
- Special copy assembly

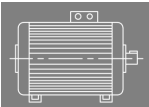

HP 3
kW 2.2
n 18.000 r.p.m
V 220-240
Hz 300
A 6.7

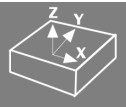

x 585 mm
y 300 mm
z 250 mm



6 - 8 BAR

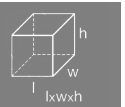

1450x1400x1800mm



300 kg / 350 kg

FN 180HP

Alüminyum Köşe Pres Makinesi (hidro-pnömatik)
Aluminium Corner Crimping Machine
(hydro-pneumatic)

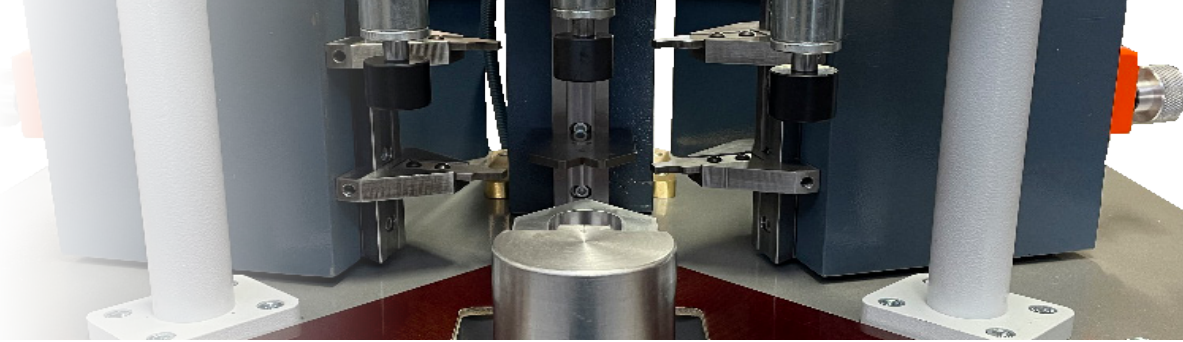

ALU
PVC
WD



TR Özellikler

- FN 180HP, alüminyum profillerin köşe birleştirme (pres) işlemleri için kullanılır.
- Hidro-pnömatik ve kam çalışma sistemi sayesinde kaliteli alüminyum köşe birleştirme (pres) işlemleri
- Kam çalışma sistemi sayesinde 2 x 7.000 kilogram itme kapasitesi
- İki veya üç noktadan presleme imkanı
- Uzun ömürlü, yüksek basınca dayanıklı çelik makine tablası
- Profillerin yüksekliğine göre kolay ayarlanabilir takım sistemi
- Presleme işlemi birbiri ile senkronize olarak hareket eden hidro-pnömatik presleme kafaları sayesinde olmaktadır.
- Merkezleme gönyesinin aşağı/yukarı hareketi ile profilin rahat çevrilmesi
- Çift taraflı profil yürütme ünitesi
- Geniş ve yüksek profilleri besleme
- Silindirlerin ilerlemesi ve profil dayama milimetrik olarak cetvel sistemi ile ayarlanabilmektedir.
- Kullanımı ve ayarlanması kolay
- Mobil kontrol paneli
- Makine, hızlı bıçak değişimi ile garanti edilen üretkenlik açısından yüksek performansa sahiptir.

Standart Ekipmanlar

- 4 x 5mm ezme seti
- 2 x 2mm ezme seti
- Sağ ve sol besleme konveyörü
- 2 x pnömatik dikey mengene

Opsiyonel Ekipmanlar

- Özel ezme seti

EN Features





- FN 180HP is used for corner crimping of aluminium profiles.
- Quality aluminum corner crimping processes thanks to the hydro-pneumatic and cam working system
- Internal crimping force multiplication cam system, capable of developing a thrust of up to 14000 kg at 7 bar using a hydro-pneumatic cylinder
- Two or three point crimping possible
- Long-lasting, high-pressure resistance steel machine table
- Practically adjustment of the knives according to the shape and height of the profiles
- Double-acting centering setsquare returns to the home position under the table after crimping
- Convenient profile rotation by up/down movement of centering miter
- Double sided conveyor unit for convenient profile processing
- Practically adjustment of the cylinder feed and profile stops by means of the milimetric ruler
- Easy to use and adjust
- Mobile, adjustable control panel
- The machine features high performance in terms of productivity, guaranteed by the rapid blade change.

Standard Equipments

- 4 x 5mm crimping set
- 2 x 2mm crimping set
- Left and right profile support
- 2 x pneumatic vertical clamp

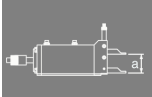
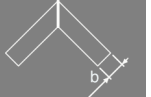
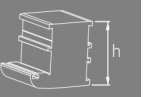
Optional Equipments

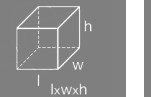
- Crimping set for custom profiles

					
a 180mm	b min. 20mm b max. 148mm	h 200mm	6 - 8 BAR	850x1000x1250mm	450 kg / 500 kg

FN 880KM

Otomatik Orta Kayıt Alıştırma Makinesi
Automatic End Milling Machine



ALU
PVC
WD

TR Özellikler

– FN 880KM, alüminyum ve plastik profillerin hassas şekilde orta kayıt alıştırma işlemlerinde kullanılan, Hidro-Pnömatik çalışma sistemiyle kaliteli operasyonlara imkan sağlayan orta kayıt alıştırma (kertme) makinesidir.

- Hidro-pnömatik hareket ile kaliteli ve hassas alıştırma operasyonları
- İşlemin başlangıç noktasına otomatik olarak dönmesi
- Pnömatik hareket sayesinde seri bıçak değiştirme sistemi
- Pnömatik dikey ve yatay mengenerler
- Dereceli gönye ile 45°-90° arasında alıştırma işlemleri
- Koruma kapağı sayesinde güvenli çalışma
- Emniyet sensörü sayesinde emniyetli çalışma
- Burç malzemeler ile ayarlanabilir kesme derinliği
- Soğutma sistemi

Standart Ekipmanlar

- 1x pnömatik dikey mengene
- 1x pnömatik yatay mengene
- Soğutma sistemi
- Hava tabancası

Opsiyonel Ekipmanlar

- Kesme seti
- Trifaze sistem

EN Features

– FN 880KM, machine which work with hydro-pneumatic system, ideal for the quality end milling operations on aluminum and PVC profiles precisely.

- High quality end milling operations by means of the hydro-pneumatic system
- Automatic returning to process starting point
- Easy blade replacement with pneumatic motion
- Pneumatic vertical and horizontal clamps
- End milling operations at between 45°-90° with graded miter
- Safety operations with safety guard
- Secure operation by the cover equipped with a safety sensor
- Practical cutter adjustment by means of the gap parts
- Cooling system

Standard Equipments

- 1x pneumatic vertical clamp
- 1x pneumatic horizontal clamp
- Cooling system
- Air gun

Optional Equipments

- Cutter set
- Spray tool lubrication system
- Three-phase system

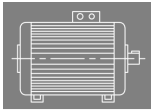

HP 1.5
kW 1.1
n 3000 r.p.m
V 220-240
Hz 50-60
A 3

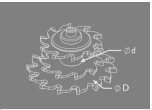

30 mm
OD 140 mm
Od 30 mm

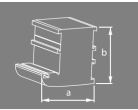

a 210 mm
b 160 mm



6 - 8 BAR

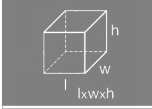

830x970x1110mm



136 kg / 176kg

FN 800KM

Portatif Orta Kayıt Alıştırma Makinesi
Portable End Milling Machine

ALU
PVC
WD

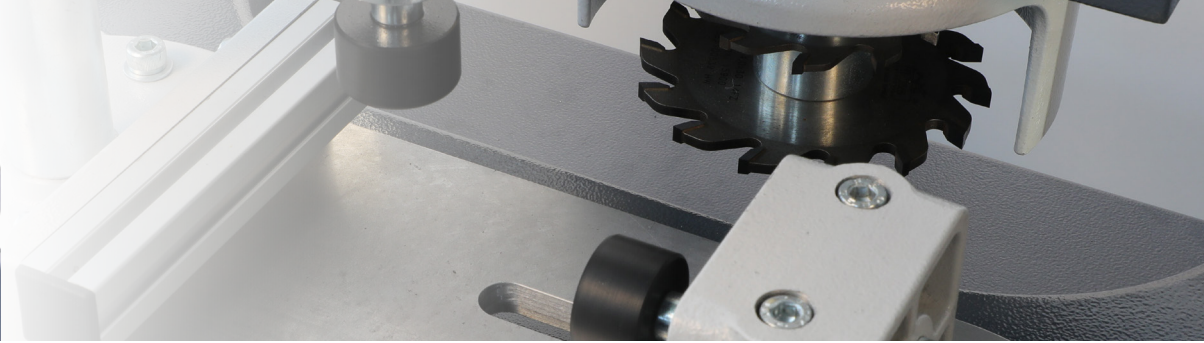

TR Özellikler

- FN 800KM, alüminyum ve PVC profillerin hassas şekilde orta kayıt alıştırma (kertme) operasyonlarında kullanılan portatif kesme makinesidir.
- Dikey ve yatay mengene sistemi
- Ergonomik tasarımı sayesinde kolay ve güvenli çalışma
- Burç parçaları ile ayarlanabilir kesme derinliği
- Manuel hareket ile kaliteli kertme operasyonları

Opsiyonel Ekipmanlar

- Kesme Seti
- FN ST300 Makine Standı
- Trifaze sistem

EN Features

- FN 800KM, portable machine which works manually, ideal for end milling operations on PVC and aluminum profiles precisely.
- Vertical and horizontal clamping system
- Ease of use and secure operation by ergonomic design
- Practical cutter adjustment by means of the gap parts
- High quality end milling operations by means of the manual operation

Optional Equipments

- Cutter Set
- FN ST300 Machine cabinet
- Three-phase system

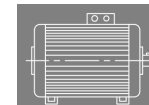

HP 1.5
kW 1.1
n 3000 r.p.m
V 220-240
Hz 50-60
A 3



ØD 140 mm
Ød 30 mm

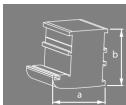

a 125 mm
b 65 mm

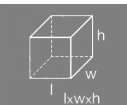

590x390x480mm



26 kg
/ 27kg

FN 2500

4'lü Alüminyum Mentеше Yeri Açma Makinesi 4 Head Aluminium Hinge Slot Drilling Machine

ALU
PVC
WD



TR Özellikler

- FN 2500, alüminyum malzemelere hidro pnömatik hareketle standart ve hassas şekilde aynı anda 4 menteşe yuvası açma operasyonları için kullanılır.
- İstenen ölçüde menteşe yuvalarını açma operasyonları
- Hidro pnömatik hareket sayesinde hassas menteşe yeri açma imkanı
- Pratik yuva derinliği ayarlama imkanı
- Min - max. ebatları alüminyum malzemenin işlem süresi maksimum 10 saniyedir.
- Makine üzerindeki tüm motorlar mil üzerinde hareketlidir.
- Bağımsız çalışma özelliğine sahip motorlar sayesinde isteğe göre 1,2 veya 3 menteşe deliği açabilme imkanı
- Arka dayamadaki cetvel sayesinde hatasız ve kolay ayarlama imkanı
- Pnömatik mngeneler sayesinde emniyetli çalışma imkanı
- Seri imalatlarda kapak üzerindeki 4 menteşe yuva sını tek işlemde açma imkanı
- Talaş toplama haznesi

Standart Ekipmanlar

- 4x delici bıçak (4 adet)
- 4x pnömatik dikey mngene
- Hava tabancası
- Soğutma sistemi

Opsiyonel Ekipmanlar

- Ekstra motor

EN Features

- FN2500, used for drilling 4 hinge slots at the same time on aluminium materials in standard and precisely with hydro-pneumatic motion.
- Drills 4 hinge slots in desired size at the same time
- Precision hinge slot drilling operations with Hydro-Pneumatic motion
- Practically allows adjustment of slot depth
- Processing time is 10 seconds for aluminum materials with minimum maximum size
- All motors are moving on the machine
- Possibility to drilling 1,2 or 3 hinge slots optionally thanks to independent motors
- Scale at the back gauge allows accurate and easy adjustment
- Quality and safe hinge slot drilling operations with pneumatic vertical clamps
- 4 hinges on the profile are drilling in a single process for serial production
- Dust collection area

Standard Equipments

- 4x punching blades
- 4x pneumatic vertical clamps
- Air gun
- Cooling system

Optional Equipments

- Extra motor

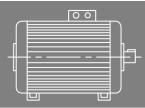

HP 1,5
kW 1,1
n 1400 r.p.m
V 380-420
Hz 50-60
A 3



35 mm



6 - 8 BAR

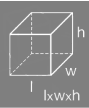

2500x800x1310mm



320 kg



54 yıllık tecrübe, kalite ve güven ile

54 years experience, with **quality** and **trust**

FN 900Plus

Tas Mentеше Yeri Açma Makinesi (değiştirilebilir kafa)
Hinge Slot Drilling Machine (replaceable head)

ALU
PVC
WD

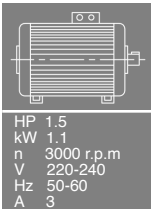
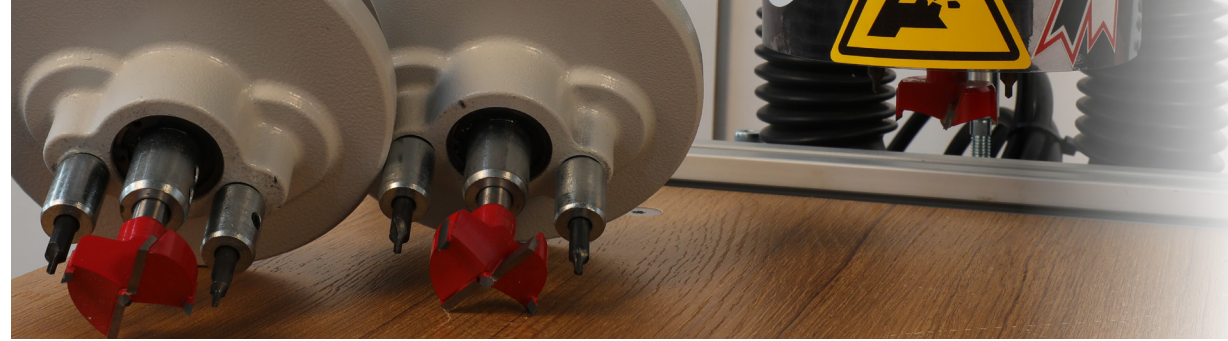

HP 1.5
kW 1.1
n 3000 r.p.m
V 220-240
Hz 50-60
A 3

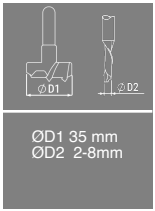

ØD1 35 mm
ØD2 2-8mm

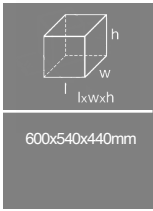

600x540x440mm

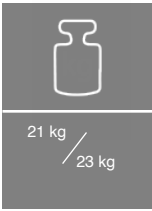

21 kg /
23 kg

TR Özellikler

– FN 900Plus, ahşap malzemelerin standart ve hassas şekilde 35mm menteşe yuvası ve 45,48,52mm (Blum, Samet, Hettich) değişken referans delik eksenleri mesafeleri için değiştirilebilir opsiyonel redüktörler sayesinde bağlantı deliklerini delme operasyonları için kullanılır.

- İstenen ölçüde tas menteşe yuvası açma imkanı
- Çeşitli menteşe markalarının değişken referans deliklerini delmek için opsiyonel redüktörlere uyum
- Kolay redüktör değiştirme imkanı
- Pratik yuva derinliği ayarlama imkanı
- Menteşeyi vidalamak için gerekli referans deliklerini açar.
- Ergonomik tasarımı ile kolay kullanım ve güvenli çalışma
- Sağlam yay sistemi
- Uzun ömürlü elektrostatik boya

Standart Ekipmanlar

- Delici bıçak
- 2mm matkap (2 adet)
- 2x manuel dikey mengene

Opsiyonel Ekipmanlar

- FN ST900 Makine standı
- FN BLM – FN HTC Değiştirilebilir redüktör

EN Features

– FN 900Plus, used for drilling 35mm hinge slot in the manner standard and precisely and drilling operations for variable reference holes axis distance of 45,48,52mm (Blum, Samet, Hettich) thanks to the replaceable heads.

- Drills hinge slot in desired size
- Compatible with optional heads for drilling variable reference holes of various hinge brands.
- Quality drilling operations with 1.5HP 3000 rpm motor power
- Ease head replacement
- Practically allows adjustment of slot depth
- Drills reference holes in order to screw in the hinge
- Ease of use and secure operation by ergonomic design
- Strong spring system
- Durable electrostatic paint

Standard Equipments

- Punching blade
- 2mm drill bits (2 pcs)
- 2x manual vertical clamps

Optional Equipments

- FN ST900 Machine cabinet
- FN BLM – FN HTC Replaceable head



ALU
PVC
WD

FN 950Plus

Pnömatik Tas Mentеше Yeri Açma Makinesi
(değiştirilebilir kafa)
Pneumatic Hinge Slot Drilling Machine
(replaceable head)

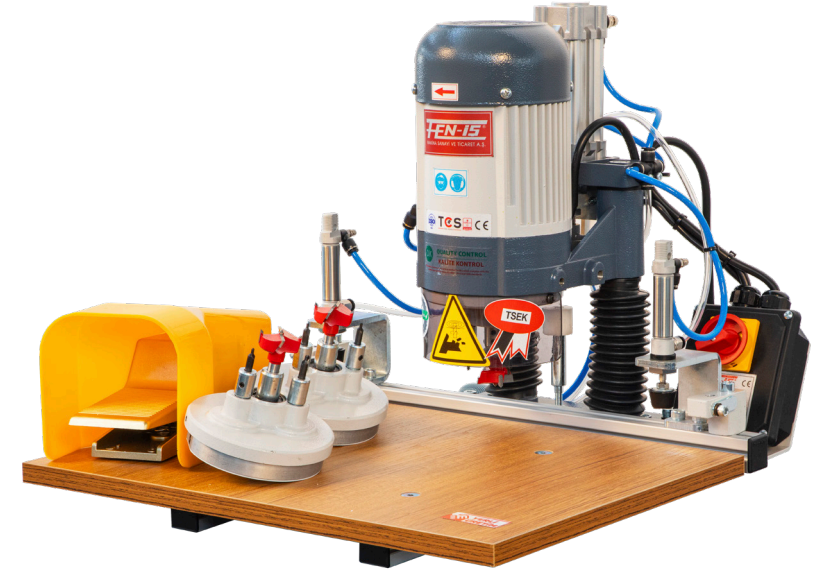

TR Özellikler

- FN 950Plus, ahşap malzemelerin pnömatik hareketle hassas şekilde 35mm menteşe yuvası ve 45,48,52mm (Blum, Samet, Hettich) değişken referans delik eksenli mesafeleri için değiştirilebilir opsiyonel redüktörler sayesinde bağlantı deliklerini delme operasyonları için kullanılır.
- Pedal ile verilen pnömatik hareket sayesinde kaliteli menteşe delme operasyonları
- İstenen ölçüde tas menteşe yuvası açma imkanı
- Çeşitli menteşe markalarının değişken referans deliklerini delmek için opsiyonel redüktörlere uyum
- Kolay redüktör değiştirme imkanı
- Pratik yuva derinliği ayarlama imkanı
- Menteşeyi vidalamak için gerekli referans deliklerini açar.
- Ergonomik tasarımı ile kolay kullanım ve güvenli çalışma
- Sağlam yay sistemi
- Uzun ömürlü elektrostatik boya

Standart Ekipmanlar

- Delici bıçak
- 2mm matkap (2 adet)
- 2x pnömatik dikey mengene

Opsiyonel Ekipmanlar

- FN ST900 Makine standı
- FN BLM – FN HTC Değiştirilebilir redüktör

EN Features

- FN 950Plus, used for drilling 35mm hinge slot with the pneumatic motion in the manner standard and precisely, drilling operations for variable reference holes axis distance of 45,48,52mm (Blum, Samet, Hettich) thanks to the replaceable heads.
- High quality hinge drilling operations thanks to the pneumatic motion provided by the pedal
- Drills hinge slot in desired size
- Compatible with optional heads for drilling variable reference holes of various hinge brands.
- Ease head replacement
- Practically allows adjustment of slot depth
- Drills reference holes in order to screw in the hinge
- Ease of use and secure operation by ergonomic design
- Strong spring system
- Durable electrostatic paint

Standard Equipments

- Punching blade
- 2mm drill bits (2 pcs)
- 2x pneumatic vertical clamps

Optional Equipments

- FN ST900 Machine cabinet
- FN BLM – FN HTC Replaceable head

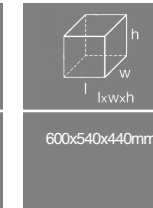
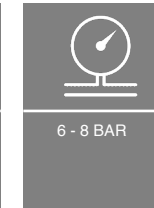
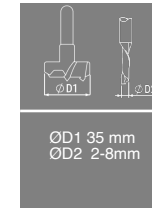
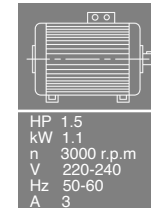





FN 2450

4'lü Tas Mentеше ve Kulp Yeri Açma Makinesi
4 Head Hinge & Handle Slot Drilling Machine

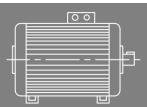
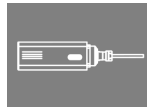
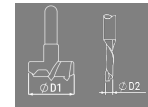
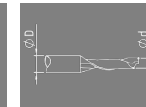
ALU
PVC
WD

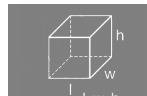

			
HP 1,5 kW 1,1 n 3000 r.p.m V 220-240 Hz 50-60 A 3	W 650 n 32.000 r.p.m V 220-240 Hz 50-60 A 2,5	ØD1 35 mm ØD2 2-8mm	ØD 8 mm Ød 5 mm
			
6 - 8 BAR	2500x870x1340mm	350 kg / 473kg	

TR Özellikler

- FN 2450, ahşap malzemelere pnömatik hareketle standart ve hassas şekilde aynı anda 4 menteşe yuvası, referans delikleri ve kulp yeri açma operasyonları için kullanılır.
- İstenen ölçüde menteşe yuvalarını açma operasyonları
- İstenen ölçüde kulp yeri açma operasyonları
- Pratik yuva derinliği ayarlama imkanı
- Menteşeyi vidalamak için gerekli referans deliklerini açar.
- Min - max. ebatdaki ahşap malzemenin işlem süresi maksimum 10 saniyedir.
- Makine üzerindeki tüm motorlar mil üzerinde hareketlidir.
- Bağımsız çalışma özelliğine sahip motorlar sayesinde isteğe göre 1,2 veya 3 menteşe deliği açabilme imkanı
- Arka dayamadaki cetvel sayesinde hatasız ve kolay ayarlama imkanı
- Pnömatik mengener sayesinde emniyetli çalışma imkanı
- Seri imalatlarda kapak üzerindeki 4 menteşe yuvasını tek işlemde açma imkanı
- Talaş toplama haznesi

Standart Ekipmanlar

- 4x delici bıçak
- 2mm matkap (8 adet)
- 2x kulp yeri için delici matkap
- 4x pnömatik dikey mengene
- Hava tabancası

Opsiyonel Ekipmanlar

- Ekstra motor
- Vakumlu bağlama sistemi

EN Features

- FN2450, used for drilling 4 hinge slots, reference holes and handle slots at the same time on wooden materials in standard and precisely with pneumatic motion.
- Drills 4 hinge slots in desired size at the same time
- Drills handle slots in desired size
- Practically allows adjustment of slot depth
- Drills reference holes in order to screw in the hinge
- Processing time is 10 seconds for wooden materials with minimum maximum size
- All motors are moving on the machine
- Possibility to drilling 1,2 or 3 hinge slots optionally thanks to independent motors
- Scale at the back gauge allows accurate and easy adjustment
- Quality and safe hinge slot drilling operations with pneumatic vertical clamps
- 4 hinges on the lid are drilling in a single process for serial production
- Dust collection area

Standard Equipments

- 4x punching blades
- 2mm drill bits (8 pcs)
- 2x drill bits for handle slot
- 4x pneumatic vertical clamps
- Air gun

Optional Equipments

- Extra motor
- Air operated vacuum clamp system

FN 1850

3'lü Tas Mentеше ve Kulp Yeri Açma Makinesi 3 Head Hinge & Handle Slot Drilling Machine

ALU
PVC
WD



TR Özellikler

- FN 1850, ahşap malzemelere pnömatik hareketle standart ve hassas şekilde aynı anda 3 menteşe yuvası, referans delikleri ve kulp yeri açma operasyonları için kullanılır.
- İstenen ölçüde menteşe yuvalarını açma operasyonları
- İstenen ölçüde kulp yeri açma operasyonları
- Pratik yuva derinliği ayarlama imkanı
- Menteşeyi vidalamak için gerekli referans deliklerini açar.
- Min - max. ebattaki ahşap malzemenin işlem süresi maksimum 10 saniyedir.
- Makine üzerindeki tüm motorlar mil üzerinde hareketlidir.
- Bağımsız çalışma özelliğine sahip motorlar sayesinde isteğe göre 1veya 2 menteşe deliği açabilme imkanı
- Arka dayamadaki cetvel sayesinde hatasız ve kolay ayarlama imkanı
- Pnömatik mengeler sayesinde emniyetli çalışma imkanı
- Seri imalatlarda kapak üzerindeki 3 menteşe yuvasını tek işlemde açma imkanı
- Talaş toplama haznesi

Standart Ekipmanlar

- 3x delici bıçak
- 2mm matkap (6 adet)
- 2x kulp yeri için delici matkap
- 3x pnömatik dikey mengene
- Hava tabancası

Opsiyonel Ekipmanlar

- Ekstra motor
- Vakumlu bağlama sistemi

EN Features





- FN1850, used for drilling 3 hinge slots, reference holes and handle slots at the same time on wooden materials in standard and precisely with pneumatic motion.
- Drills 3 hinge slots in desired size at the same time
- Drills handle slots in desired size
- Practically allows adjustment of slot depth
- Drills reference holes in order to screw in the hinge
- Processing time is 10 seconds for wooden materials with minimum maximum size
- All motors are moving on the machine
- Possibility to drilling 1 or 2 hinge slots optionally thanks to independent motors
- Scale at the back gauge allows accurate and easy adjustment
- Quality and safe hinge slot drilling operations with pneumatic vertical clamps
- 3 hinges on the lid are drilling in a single process for serial production
- Dust collection area

Standard Equipments

- 3x punching blades
- 2mm drill bits (6 pcs)
- 2x drill bits for handle slot
- 3x pneumatic vertical clamps
- Air gun

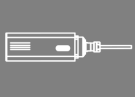
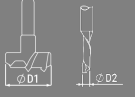
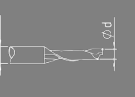
Optional Equipments

- Extra motor
- Air operated vacuum clamp system

 HP 1.5 kW 1.1 n 3000 r.p.m V 220-240 Hz 50-60 A 3	 W 650 n 32.000 r.p.m V 220-240 Hz 50-60 A 2,5	 ØD1 35 mm ØD2 2-8mm	 ØD 8 mm Ød 5 mm
 6 - 8 BAR	 1900x870x1340mm	 280 kg / 373kg	

FN 1250

2'li Tas Mentеше ve Kulp Yeri Açma Makinesi
2 Head Hinge & Handle Slot Drilling Machine

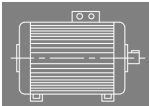

HP 1.5
kW 1.1
n 3000 r.p.m
V 220-240
Hz 50-60
A 3

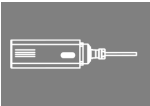

W 650
n 32,000 r.p.m
V 220-240
Hz 50-60
A 2,5

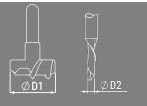

ØD1 35 mm
ØD2 2-8mm

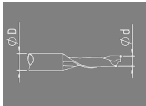

ØD 8 mm
Ød 5 mm



6 - 8 BAR

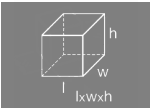

1300x870x1340mm



212 kg /
274 kg

ALU
PVC
WD



TR Özellikler

- FN 1250, ahşap malzemelere pnömatik hareketle standart ve hassas şekilde aynı anda 2 menteşe yuvası, referans delikleri ve kulp yeri açma operasyonları için kullanılır.
- İstenen ölçüde menteşe yuvalarını açma operasyonları
- İstenen ölçüde kulp yeri açma operasyonları
- Pratik yuva derinliği ayarlama imkanı
- Menteşeyi vidalamak için gerekli referans deliklerini açar.
- Min - max. ebatlarıdaki ahşap malzemenin işlem süresi maksimum 10 saniyedir.
- Makine üzerindeki tüm motorlar mil üzerinde hareketlidir.
- Bağımsız çalışma özelliğine sahip motorlar sayesinde isteğe göre 1 menteşe deliği açabilme imkanı
- Arka dayamadaki cetvel sayesinde hatasız ve kolay ayarlama imkanı
- Pnömatik mngeneler sayesinde emniyetli çalışma imkanı
- Seri imalatlarda kapak üzerindeki 2 menteşe yuvasını tek işlemdede açma imkanı
- Talaş toplama haznesi

Standart Ekipmanlar

- 2x delici bıçak
- 2mm matkap (4 adet)
- 2x kulp yeri için delici matkap
- 2x pnömatik dikey mngene
- Hava tabancası

Opsiyonel Ekipmanlar

- Ekstra motor

EN Features

- FN 1250, used for drilling 2 hinge slots, reference holes and handle slots at the same time on wooden materials in standard and precisely with pneumatic motion.
- Drills 2 hinge slots in desired size at the same time
- Drills handle slots in desired size
- Practically allows adjustment of slot depth
- Drills reference holes in order to screw in the hinge
- Processing time is 10 seconds for wooden materials with minimum maximum size
- All motors are moving on the machine
- Possibility to drilling 1 hinge slot optionally thanks to independent motors
- Scale at the back gauge allows accurate and easy adjustment
- Quality and safe hinge slot drilling operations with pneumatic vertical clamps
- 2 hinges on the lid are drilling in a single process for serial production
- Dust collection area

Standard Equipments

- 2x punching blades
- 2mm drill bits (4 pcs)
- 2x drill bits for handle slot
- 2x pneumatic vertical clamps
- Air gun

Optional Equipments

- Extra motor

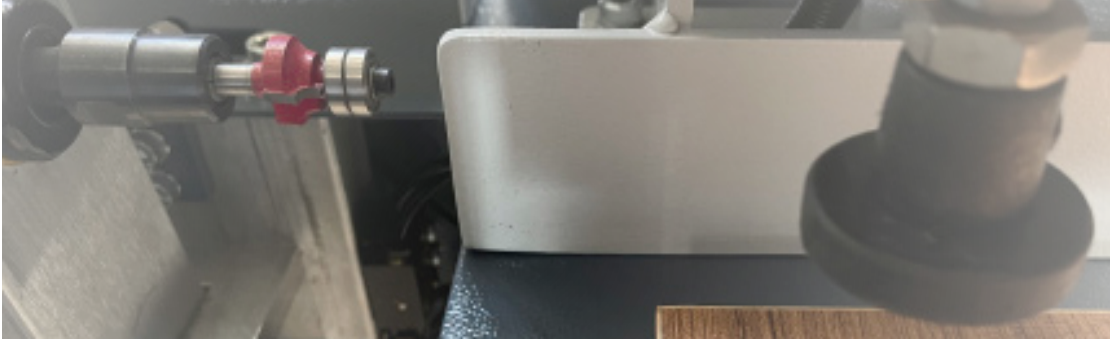

ALU
PVC
WD

FN 1000

PVC Köşe Trim Makinesi
PVC Corner Trim Machine



TR Özellikler

- FN 1000, ahşap malzemelerin PVC kenar bantlama işleminden sonra köşe temizleme (trim) operasyonları için kullanılır.
- Yüksek devirli motoru ile hassas köşe temizleme operasyonları
- 3mm pvc bant kalınlığına kadar ayarlanabilir
- Sağlam sac gövde
- 5cm yükseklik
- Uzun ömürlü elektrostatik boya

Standart Ekipmanlar

- Köşe trim bıçağı
- Alyan anahtarı

EN Features

- FN 1000, used for corner cleaning (trim) operations after PVC edge banding of wooden materials.
- Precisely corner cleaning (trimming) operations with high speed motor
- Adjustable up to 3mm pvc tape thickness
- Durable sheet metal machine body
- 5 cm height
- Durable electrostatic paint

Standard Equipments

- Corner cleaning blade
- Allen wrench



W 650
n 32.000 r.p.m
V 220-240
Hz 50-60
A 2,5

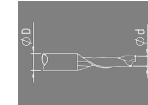

ØD 19 mm
Ød 6 mm



6 - 8 BAR



790x700x430mm



39 kg
/ 71 kg

FN 1100

Kesme & Açma Makinesi
Cutting & Dovetail Slot Machine

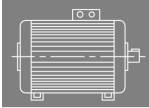

HP 1.5
kW 1.1
n 3000 r.p.m
V 220-240
Hz 50-60
A 3

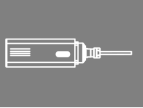

W 850
n 32.000 r.p.m
V 220-240
Hz 50-60
A 2,5



ØD 300 mm
Ød 30-32 mm
S 3.2 mm
n 3000 r.p.m

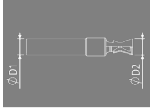

ØD1 8 mm
ØD2 8 mm

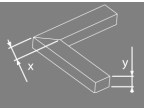

X 75 mm
Y 84 mm



6 - 8 BAR

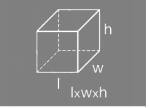

780x580x1520mm



60 kg
/ 98 kg

ALU
PVC
WD



TR Özellikler

- FN 1100, ahşap çerçeve profillerinin dereceli kesim ve köşe birleştirme kanallarını açma işlemleri için kullanılır.
- Ahşap profilede önce kesim sonrasında çift köşe birleştirme kanalı açma imkanı
- Sağa ve sola 15°, 22.5°, 30°, 45° ve 90° açılarla kesim
- Otomatik kesim ve köşe birleştirme kanalı açma imkanı
- Kolay ayar imkanı
- Kırılmaç kesime özel tasarlanmış pnömatik yan pistonlar
- Pnömatik dikey mengener ile hassas ve güvenli kesim işlemleri
- Özel alaşımli alüminyum döküm makine gövdesi
- Uzun ömürlü elektrostatik boya

Standart Ekipmanlar

- 1x Ø300 mm testere
- 2x kırılmaç bıçağı
- 2x pnömatik dikey mengene
- 2x pnömatik yatay mengene
- Hava tabancası

Opsiyonel Ekipmanlar

- Trifaze sistem

EN Features

- FN 1100, used for angular cutting and dovetail assembling processes of wooden profiles.
- Possibility to open double dovetail slot after cutting in wooden profiles
- Cutting at 15°, 22.5°, 30°, 45°, 90° right and left angle fixing
- Possibility to automatic cutting and opening dovetail slots for wooden profiles.
- Easy adjustment
- Custom designed pneumatic horizontal-piston for dovetail operations
- Precisely and safe cutting operations with pneumatic vertical clamps
- Machine body made of special aluminum alloy
- Durable electrostatic paint

Standard Equipments

- 1x Ø300 mm saw blade
- 2x dovetail blade
- 2x pneumatic vertical clamps
- 2x pneumatic horizontal pistons
- Air gun

Optional Equipments

- Three-phase system

FN 500 FN 600

Ahşap Köşe Birleştirme Makinesi (tek/çift bıçak)
Dovetail Machine (single/double blade)

ALU
PVC
WD

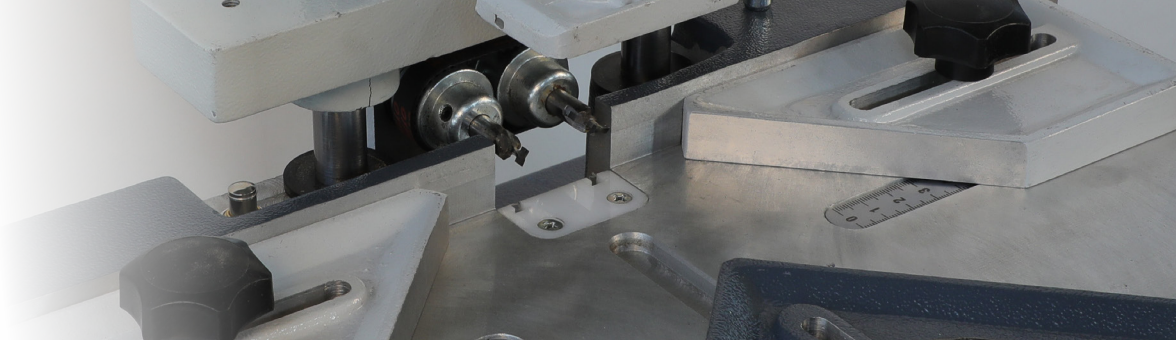

TR Özellikler

- FN 500 ve FN 600, ahşap çerçeve profillerine köşe birleştirme kanallarını (kırılmalı yeri) açma ve birleştirme işlemleri için kullanılır.
- Merkezlemeyi sağlayan gönye sistemi
- Çift kırılmalı yeri açma imkanı (FN 600)
- Ergonomik tasarımı sayesinde kolay ve güvenli çalışma
- Manuel hareket sayesinde kaliteli operasyonlar
- Özel alaşım alüminyum döküm makine gövdesi
- Uzun ömürlü elektrostatik boya

Standart Ekipmanlar

- Mengene
- 1x freze ucu (FN 500)
- 2x freze ucu (FN 600)
- Alyan anahtarı

Opsiyonel Ekipmanlar

- Kırılmalı plastiği
- FN ST900 Makine standı

EN Features

- FN 500 and FN 600, used for opening dovetail slots on wooden frame profiles and performing corner assembling processes.
- Mitre system for centering
- Possibility to open double dovetail slot (FN 600)
- Ease of use and secure operation by ergonomic design
- Quality operations thanks to manual movement
- Machine body made of special aluminum alloy
- Durable electrostatic paint

Standard Equipments

- Clamp
- 1x milling cutter (FN 500)
- 2x milling cutter (FN 600)
- Allen wrench

Optional Equipments

- Dovetail plastics
- FN ST900 Machine cabinet

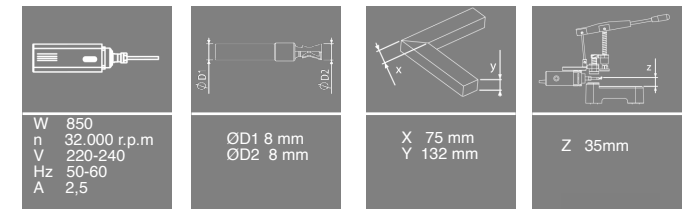

W 850
n 32.000 r.p.m
V 220-240
Hz 50-60
A 2,5

ØD1 8 mm
ØD2 8 mm

X 75 mm
Y 132 mm

Z 35mm

h
w
l
lxwxh

510x400x320 mm

12 kg
/ 13 kg

FN 250

Portatif Tablalı Kesim Makinesi Ø250mm
Portable Table Saw Machine Ø250mm



ALU
PVC
WD

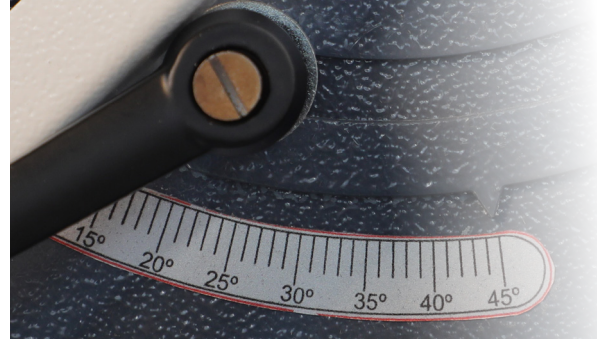

TR Özellikler

– FN 250, ahşap, laminat parke ve sunta benzeri malzemelerin kesim işlemi için kullanılır.

- 45°'ye kadar istenen tüm açılarda sabit kesim
- Küçük boyutu ve hafifliği ile taşıma kolaylığı
- Ölçü cetveli ile pratik ayar imkanı
- Güçlü ve sessiz motoru sayesinde hassas ve kaliteli kesim operasyonları
- Testere muhafazası ile emniyetli kesim
- Toz toplama haznesi, tozsuz ve sağlıklı kesim

Standart Ekipmanlar

- Alyan anahtar

Opsiyonel Ekipmanlar

- Ø250 mm testere

EN Features

– FN 250, used for cutting of wood laminate floor and chipboard materials.

- Angular cutting adjustable up to 45°
- Ease carrying with a small sized and lightweight
- Practical adjustment opportunity with measuring scale
- Quality cutting operations with strong and silent motor
- Safe cutting with saw barrier
- Dust collector provides a dust free and healthy cutting

Standard Equipments

- Allen wrench

Optional Equipments

- Ø250 mm saw blade

FN 220 / FN 380

Zımpara Makinesi (220/380)
Sanding Machine (220/380)



TR Özellikler

– FN 220 ve FN 380, ahşap yüzeylerin zımpara işleminde kullanılır.

EN Features

– FN 220 and FN 380, used for sanding operations of wood surfaces.

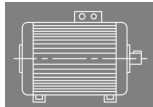

HP 1
kW 0,75
n 3.000 r.p.m
V 220-240
Hz 50-60
A 2



ØD 250 mm
Ød 30-32 mm
n 3000 r.p.m

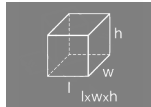

540x490x340mm



19 kg / 20 kg

FN 220

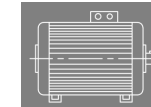

V 220-240
HP 0,75
n 3000 r.p.m
Hz 50-60

FN 380

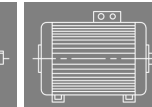

V 380-400
HP 0,50
n 3000 r.p.m
Hz 50-60

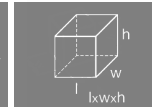

440x160x210mm



7 kg

FN 3000K

Konveyör
Conveyor



TR Özellikler

- FN 350, FN 400 serisi kesim makinelerinde alüminyum, ahşap ve plastik malzemeler için yürütme ünitesi olarak kullanılır.
- Makineye göre pratik yükseklik ayarı
- Ölçü dayama ve cetvel
- Manuel kontrol
- 3.000 mm uzunluk

EN Features

- FN 350, FN 400 series used for conveying of aluminum, wood and plastic materials for cutting machines.
- Practical height adjustment according to machine
- Measurement gauge and ruler
- Manual control
- 3.000 mm length

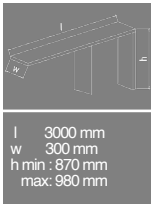

l 3000 mm
w 300 mm
h min : 870 mm
max: 980 mm



32 kg

FN 3000DK

Dijital Konveyör
Digital Conveyor



TR Özellikler

- FN 350, FN 400 ve FN 420 serisi kesim makinelerinde alüminyum, ahşap ve plastik malzemeler için bilgisayar kontrollü yürütme ünitesi olarak kullanılır.
- Dokunmatik dijital ekranda girilen ölçülere dayama otomatik olarak gider.
- 0,1 mm ölçü hassasiyeti
- Bilgisayar kontrollü dokunmatik ekran
- Otomatik pozisyonlama

EN Features

- FN 350, FN 400 series, used for conveying of aluminum, wood and plastic materials for cutting machines.
- Self-positioning of the conveyor stop according to the values on the digital screen
- 0,1 mm measurement accuracy
- Touchscreen with computer controlled
- Automatic positioning

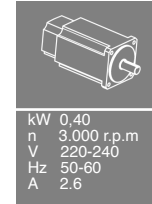

kW 0,40
n 3.000 r.p.m
V 220-240
Hz 50-60
A 2,6

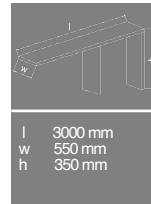

l 3000 mm
w 550 mm
h 350 mm

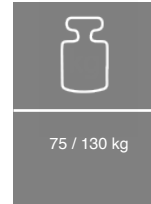

75 / 130 kg

FN ST300

Makine Sehpaası
Machine Cabinet



TR Özellikler

- FN 300, FN 320, FN 700FR ve FN 800KM portatif makineleri için sehpa olarak kullanılır.
- Sağlam sac gövde
- Takımlar için iki bölmeli raf
- Kapalı ve kilitli dolap

EN Features

- FN 300, FN 320, FN 700FR and FN 800KM, used as a cabinet for portable machines.
- Durable sheet metal body
- Double compartment shelf for tools
- Closed and locked cupboard



630x400x800mm

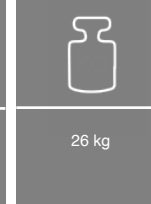

26 kg

FN ST900

Makine Sehpaası
Machine Cabinet



TR Özellikler

- FN 900, FN 950 serisi, FN 250, FN 500 ve FN 600 portatif makineleri için sehpa olarak kullanılır.
- Sağlam sac gövde
- Takımlar için iki bölmeli raf
- Kapalı ve kilitli dolap

EN Features

- FN 900 series, FN 950 series, FN 250, FN500 and FN 600, used as a cabinet for portable machines.
- Durable sheet metal body
- Double compartment shelf for tools
- Closed and locked cupboard

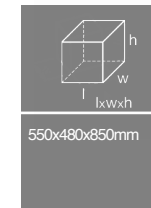

550x480x850mm



28 kg

www.fenismakina.com

since 1970

